

**MHI**  
**Copy 3**

**FM 23-7**

**WAR DEPARTMENT**

**BASIC FIELD MANUAL**

**U. S. CARBINE, CALIBER  
.30, M1**

**May 20, 1942**

**FM 23-7**

**BASIC FIELD MANUAL**



**U. S. CARBINE, CALIBER .30, M1**



**UNITED STATES  
GOVERNMENT PRINTING OFFICE  
WASHINGTON : 1942**

WAR DEPARTMENT,  
WASHINGTON, May 20, 1942.

FM 23-7, U. S. Carbine, Caliber .30, M1, is published for the information and guidance of all concerned.

[A. G. 062.11 (4-24-42).]

BY ORDER OF THE SECRETARY OF WAR:

G. C. MARSHALL,  
*Chief of Staff.*

OFFICIAL:

J. A. ULIO,  
*Major General,*  
*The Adjutant General.*

DISTRIBUTION:

R 1-7, 10, 11, 17, 18 (3); Bn 2-7, 9-11, 17-19 (3); IBn 1 (3); C 2, 5-7, 17, 18 (20); 3, 4, 9, 10, 19 (10); IC 1, 11 (20).

(For explanation of symbols see FM 21-6.)

## TABLE OF CONTENTS

	Paragraphs	Pages
APPENDIX. Score card for carbine, caliber .30 M1-----		iv
CHAPTER 1. Mechanical training.		
Section I. General-----	1-6	1
II. Disassembly and assembly-----	7-11	4
III. Care and cleaning-----	12-18	13
IV. Functioning-----	19-20	18
V. Operation-----	21-29	21
VI. Immediate action and stoppages---	30-32	23
VII. Spare parts and accessories-----	33-34	27
VIII. Ammunition-----	35-38	28
IX. Individual safety precautions-----	39	30
CHAPTER 2. Marksmanship—known-distance targets.		
Section I. General-----	40-45	31
II. Preparatory marksmanship training-----	46-53	33
III. Qualification courses-----	54-56	70
IV. Range practice-----	57-59	72
V. Equipment—known-distance targets and ranges-----	60-61	88
CHAPTER 3. Marksmanship—moving ground targets.		
Section I. General-----	62-63	93
II. Moving personnel-----	64	94
III. Moving vehicles-----	65-67	94
IV. Moving targets and ranges and range precautions-----	68-69	95
CHAPTER 4. Marksmanship—air targets.		
Section I. Air targets for carbine-----	70-71	97
II. Technique of fire-----	72-74	97
III. Marksmanship training-----	75-78	99
IV. Miniature range practice-----	79-82	105
V. Ranges, targets, and equipment-----	83-85	108
CHAPTER 5. Firing at field targets-----	86-93	109
CHAPTER 6. Advice to instructors.		
Section I. General-----	94	119
II. Mechanical training-----	95	119
III. Marksmanship—known-distance targets-----	96-110	119
IV. Marksmanship—air targets-----	111-113	135
V. Field target firing-----	114	136
INDEX-----		137

## SCORE CARD FOR CARBINE M-1

-----  
(Name)  
-----

-----  
(ASN)  
-----

-----  
(Organization)  
-----

Targets.....	Standing and sitting	100 yards				Total
Order.....						
Date.....						

-----  
(Signature of scorer)  
-----

-----  
(Signature of officer)  
-----

Targets.....	Standing and kneeling	100 yards				Total
Order.....						
Date.....						

-----  
(Signature of scorer)  
-----

-----  
(Signature of officer)  
-----

Targets.....	Standing and sitting	200 yards				Total
Order.....						
Date.....						

-----  
(Signature of scorer)  
-----

-----  
(Signature of officer)  
-----

Targets.....	Standing and kneeling	200 yards				Total
Order.....						
Date.....						

-----  
(Signature of scorer)  
-----

-----  
(Signature of officer)  
-----

Targets.....	Standing to prone	300 yards				Total
Order.....						
Date.....						

-----  
(Signature of scorer)  
-----

-----  
(Signature of officer)  
-----

Qualification: \_\_\_\_\_

Grand aggregate.....

Date....., 19..

Certified correct:

Commanding Co.....

# BASIC FIELD MANUAL

## U. S. CARBINE, CALIBER .30 M1

### CHAPTER I

#### MECHANICAL TRAINING

	Paragraphs
SECTION I. General .....	1-6
II. Disassembly and assembly.....	7-11
III. Care and cleaning.....	12-18
IV. Functioning.....	19-20
V. Operation.....	21-29
VI. Immediate action and stoppages.....	30-32
VII. Spare parts and accessories.....	33-34
VIII. Ammunition.....	35-38
IX. Individual safety precautions.....	39

#### SECTION I

#### GENERAL

■ 1. DESCRIPTION OF CARBINE.—The U. S. carbine, caliber .30, M1, is a self-loading shoulder weapon (see fig. 1). It is gas operated, magazine fed, and air cooled. It weighs approximately 5 pounds. The weapon is fed from a box type magazine having a capacity of 15 rounds.

■ 2. GENERAL DATA.—*a. Dimensions.*—(1) *Barrel.*

Diameter of bore.....inches... 30

Number of grooves..... 4

Length of barrel.....inches... 17.75

(2) *Carbine.*

Over-all length of carbine.....inches... 35.50

Sight radius.....do... 22.

*b. Weight.*

Carbine without sling.....pounds... 5.12

Carbine with sling.....do... 5.23

Magazine, empty.....do... .17

Magazine, loaded.....do... .57

Total weight w/sling and loaded  
magazine.....do... 5.80

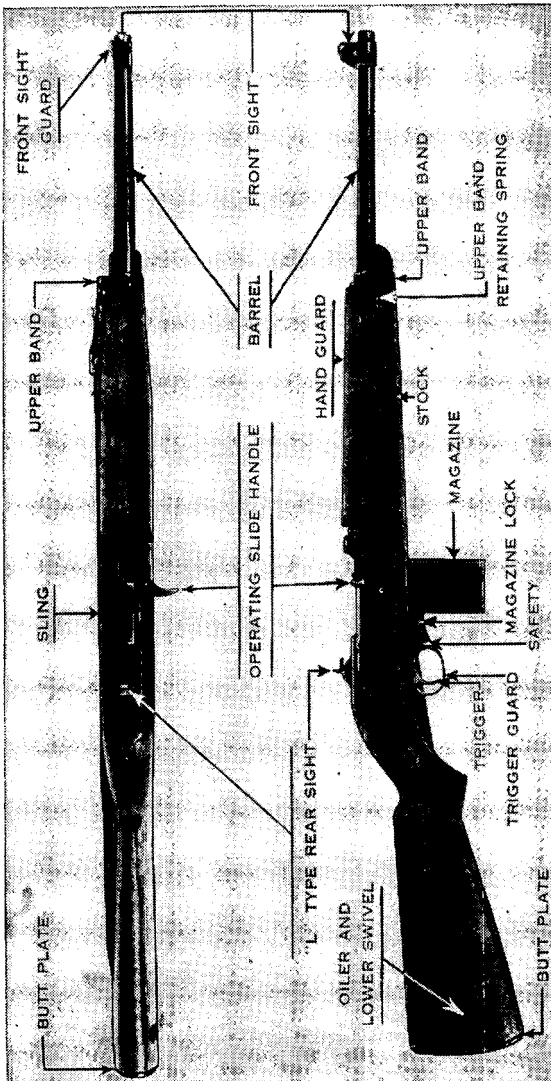

FIGURE 1.—U. S. carbine, caliber .30, M1.

■ 3. MISCELLANEOUS DATA.

Muzzle velocity	-----feet per second--	1900
Pressure in chamber (approx.)		
	pounds per square inch--	40,000
Weight of ball cartridge (approx.)		
	grains--	195
Weight of bullet (approx.)	-----grains--	110

■ 4. REAR SIGHT.—*a.* Models of the carbine initially issued will be equipped with an L-type rear sight, consisting of

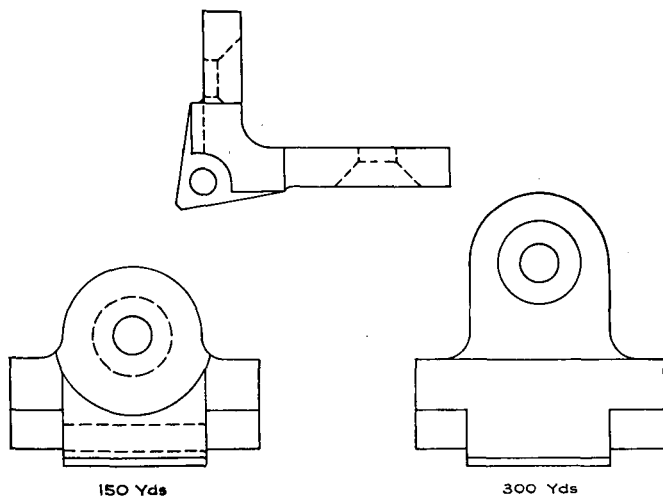

FIGURE 2.—L-type rear sight.

two arms at right angles, each pierced with an aperture. A flat spring is placed between the sight leaf and sight base to retain the sight leaf in position. Either sight may be raised into position by turning with the fingers, and the leaf is held correctly by the pressure of the spring. The apertures provided are computed for ranges of 150 and 300 yards. With this sight it will be necessary to aim off the target to secure intermediate changes in range and windage corrections. (See fig. 2.)



b. Later models of the carbine will be equipped with an adjustable sight generally similar to that shown in other figures in this manual. This sight will be graduated from 100 to 300 yards in increments of 50 yards and will provide for 3 points of left and 3 points of right windage. The amount which changes of elevation and windage will move the point of strike must be determined by experiment.

■ 5. FRONT SIGHT.—The front sight is the post type, protected by wings and adjusted laterally during assembly at the arsenal. It is locked in position, after adjustment, by riveting part of the metal base into the lock seat with a punch.

■ 6. NOMENCLATURE AND REFERENCES.—*a. Nomenclature.*—The soldier should be familiar with the names of those parts of the carbine which are frequently referred to in drill and range practice (figs. 3 to 6, inclusive).

*b. References.*—Safety precautions to be observed by troops are complete in this manual. Range officers, the officer in charge of firing, and the commander responsible for the location of ranges and conduct of firing should refer to AR 750-10 for additional safety precautions.

## SECTION II

### DISASSEMBLY AND ASSEMBLY

■ 7. WHEN TAKEN UP.—Training in disassembly and assembly is taken up as soon as practicable after the soldier receives his carbine. This training is completed before the individual does any firing with the weapon.

■ 8. ORGANIZATION.—In the company or platoon, men armed with the carbine are organized into one or more groups under their officers or selected noncommissioned officers as instructors and supervisors.

■ 9. CARE TO BE EXERCISED.—*a.* The carbine can be readily disassembled and assembled without applying force. The application of force is prohibited.

*b.* The weapon will not be disassembled or assembled against time. In all practice in disassembling the carbine, individuals will be taught to lay the parts out on a smooth, clean surface in the proper sequence for assembling.

■ 10. DISASSEMBLING.—*a. General.*—Disassembly of the carbine by the soldier is limited to those steps required for proper care and maintenance of the weapon. Further disassembly will not be made except under the supervision of an officer or ordnance personnel. Only the following parts may be removed by the individual soldier without supervision:

Sling and oiler (and lower sling swivel).

Magazine.

Hand guard.

Stock assembly.

Operating slide spring.

Operating slide spring guide rod.

Guard assembling pin.

Trigger group assembly.

Operating slide.

Bolt assembly.

Barrel and receiver assembly.

*b. Sequence.*—The disassembly of the carbine authorized to be performed by the soldier without supervision is made in the following sequence:

(1) *Sling and oiler (and lower sling swivel).*—Unsnap and remove sling from the upper sling swivel. Remove oiler and attached sling from the recess in the butt of the stock.

(2) *Magazine.*—Hold the carbine, muzzle to the front, between the right side of the body and right forearm. Hold the magazine with the left hand. With the thumb of the right hand, press the magazine lock from the right side to the left and withdraw the magazine downward out of the receiver. *CAUTION: Do not let the magazine drop to the ground.*

(3) *Hand guard.*—Place the carbine on a level surface, resting the muzzle so that the head of the upper band screw is up and to the left. Using the rim of a carbine cartridge, loosen the upper band screw about  $\frac{1}{8}$  inch. Turn the barrel over. Depress the upper band retaining spring with the base of the cartridge, and slide the upper band over the retaining spring and off the stock. With the left hand, slide the hand guard forward until its rear end is disengaged from the groove in the front end of the receiver, and remove the hand guard from the barrel.

(4) *Stock assembly.*—Grasp the small of the stock with the right hand and the barrel with the left hand, palm up. Push the safety to the left. Raise the muzzle end of the barrel from the stock until the receiver is released from the stock abutment. Remove the stock from the barrel, trigger group assembly, and receiver.

(5) *Operating slide spring and guide rod.*—Place the barrel and attached assemblies on a level surface, muzzle to



FIGURE 3.—Three main groups, U. S. carbine, caliber .30, M1.

the left, operating slide handle up. Grasp the operating spring guide rod between the thumb and forefinger of the right hand and pull the rod to the rear, disengaging it from its seat in the operating slide. Raise the rod slightly and withdraw the operating spring to the left from its well in the receiver (see fig. 7). Separate the spring from its guide rod.

(6) *Trigger group assembly.*—Cock the hammer by pulling the operating slide to the rear and pushing it forward. Turn

the barrel so that the operating slide handle is down. Punch the guard assembling pin from its seat by starting it with the small end of the operating spring guide rod held in the right hand. Pull out pin from far side with left hand.

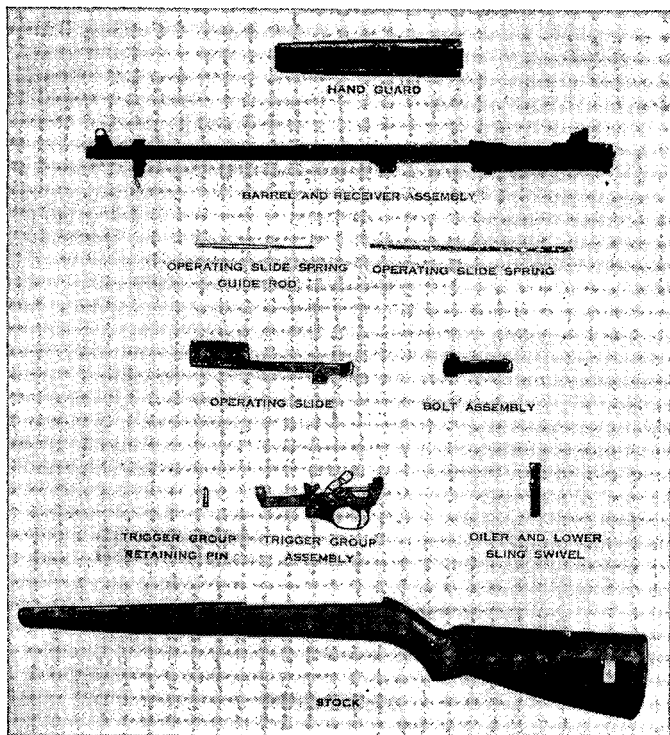

FIGURE 4.—Groups and parts to be removed for care and cleaning.

Grasp the barrel with the left hand and the trigger group assembly with the right hand as shown in figure 8. The trigger group assembly may now be removed by sliding it to the left and disengaging its undercut grooves from the corresponding grooves in the receiver.

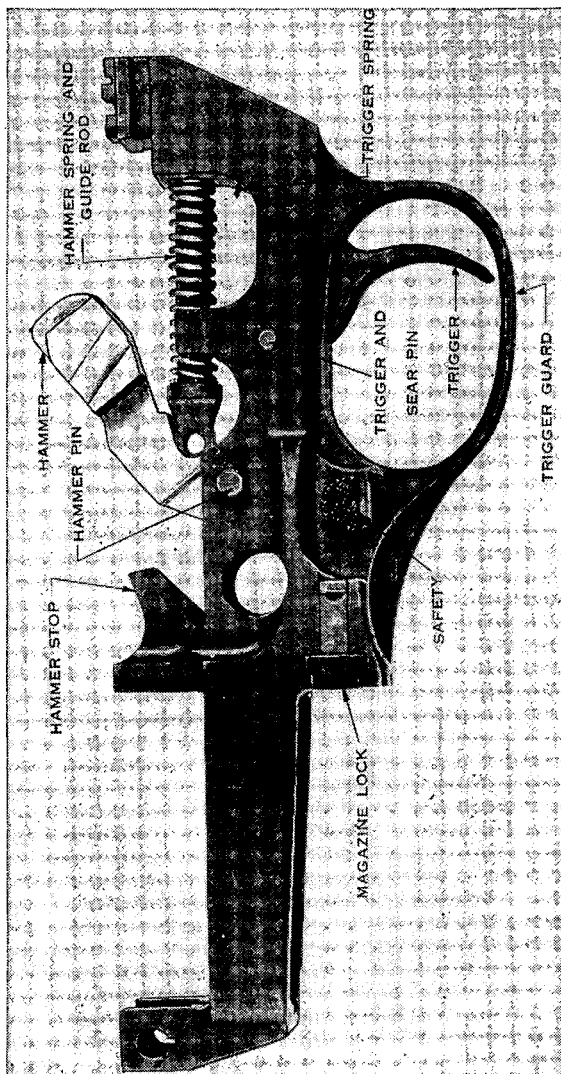

FIGURE 5.—Trigger group assembly with hammer in cocked position.

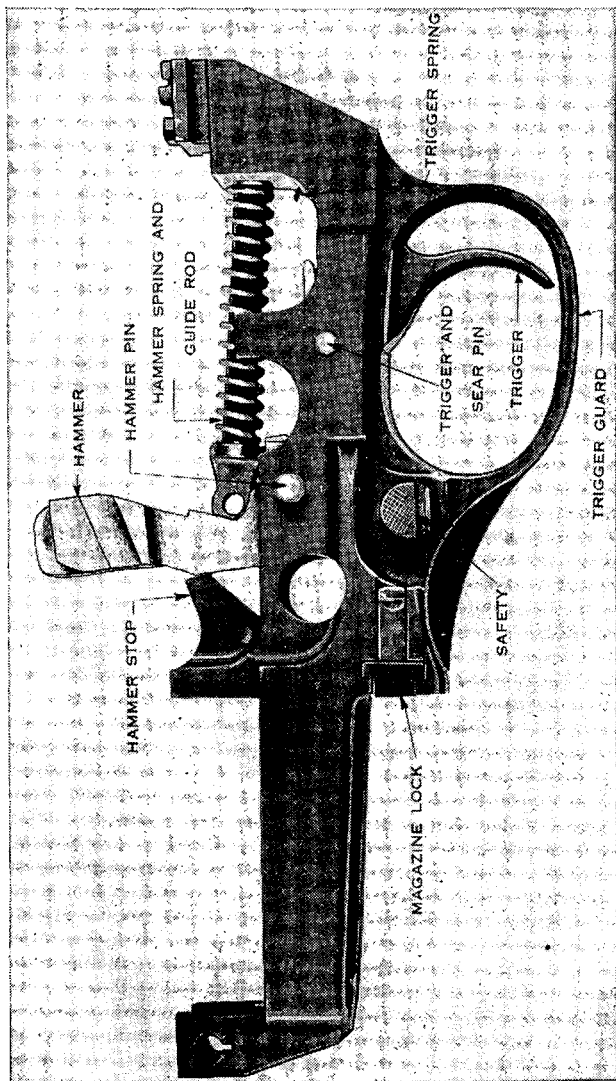

FIGURE 6.—Trigger group assembly with hammer in firing position.

(7) *Operating slide* (see fig. 9).—Rest the barrel on a level surface, muzzle to the front, receiver down. Hold the rear end of the receiver against the body with the left hand, thumb resting on top of the left side of the operating slide. Grasp the operating slide handle with the thumb and forefinger of the right hand and draw the slide slowly to the rear until the lug on the inner side of the rear end of the slide is opposite

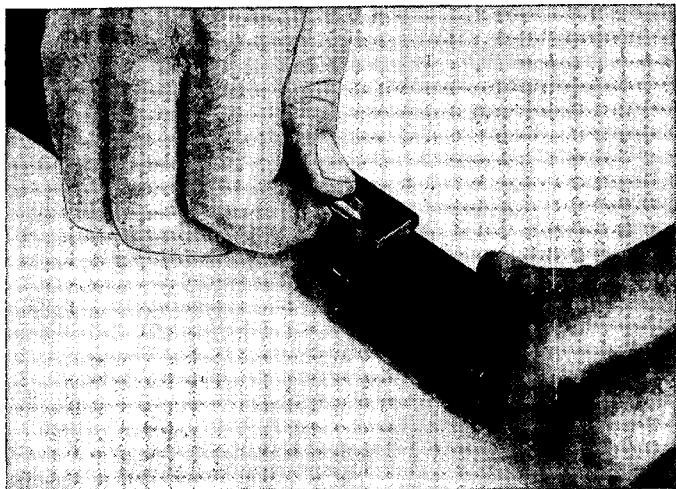

FIGURE 7.—Removing operating slide spring and guide rod.

the operating slide dismounting notch in the operating groove of the receiver. Pull the operating handle to the right and up and disengage the rear end of the slide from the operating lug on the bolt. The slide may now be removed from the barrel by a downward pressure of the left thumb on the left side of the slide, thus disengaging the lug on the slide from the left guiding groove in the under side of the barrel.

(8) *Bolt assembly*.—Hold the barrel as described in (7) above. Grasp the operating lug on the bolt between the thumb and forefinger of the right hand and move the bolt so that its front end is just in rear of the locking recesses in the receiver. Raise the front end of the bolt about 1 inch.

Rotate the bolt slightly to the right so that the tail of the firing pin is opposite its notch in the bottom of the receiver. Lift the bolt from the receiver.

■ 11. ASSEMBLING.—The carbine and its component groups are assembled in the reverse order of their disassembly.

a. *Bolt assembly.*—Grasp the operating lug of the bolt

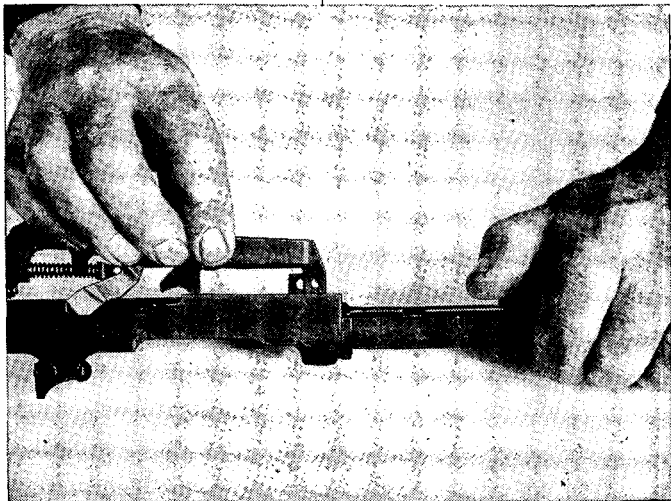

FIGURE 8.—Sliding trigger group assembly off receiver.

between the thumb and forefinger of the right hand. Hold the bolt so that the tail of the firing pin is opposite its notch in receiver, then lower the bolt into position.

b. *Operating slide.*—Grasp the forward end of the slide in the right hand, palm up. Slide the bolt forward until its forward end is about  $1\frac{1}{2}$  inches from the chamber and hold it in this position with the left thumb. Engage the operating lug of the bolt in the operating cam groove of the slide. Raise the forward end of the slide so that the dismounting lug on its left side is opposite the notch in the left groove on the under side of the barrel. Then, by slightly twisting the slide to the right, engage the operating lugs of the slide in the



operating grooves of the barrel. Move the slide and bolt to the rear until the operating slide lug is seated in its groove in the receiver. Close the bolt. (See fig. 10.)

*c. Trigger group assembly.*—Place the barrel and receiver on its left side, muzzle to the left. Replace the trigger group assembly by engaging its undercut grooves with the cor-

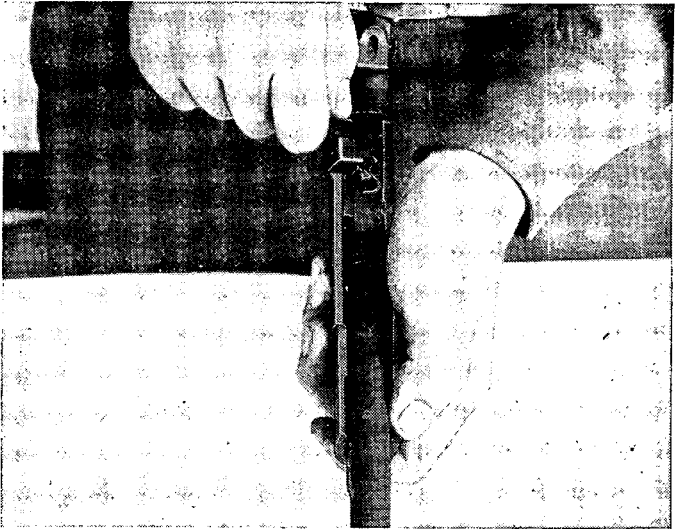

FIGURE 9.—Removing the operating slide.

responding grooves in the receiver. Replace the guard assembling pin.

*d. Operating slide spring and guide rod.*—Insert the small end of the guide rod in the loosely coiled end of the spring. Insert the closely coiled end of the spring into its well in the receiver. Steady the barrel with the left hand, and with the thumb and forefinger of the right hand on the shoulder of the guide rod, compress the spring so that the end of the guide rod may be inserted in its seat in the slide.

*e. Stock assembly and hand guard.*—Make certain the safety is to the left. Replace the barrel and assembled

groups in the stock. Replace the hand guard. Slide the upper band down over the end of the hand guard and stock until it is engaged by the upper band retaining spring. Tighten the upper band screw.

*f. Sling and oiler (and lower sling swivel).*—Attach lower loop of the sling to the oiler. Replace the oiler in its recess in the stock. Attach upper end of the sling to the upper sling swivel.

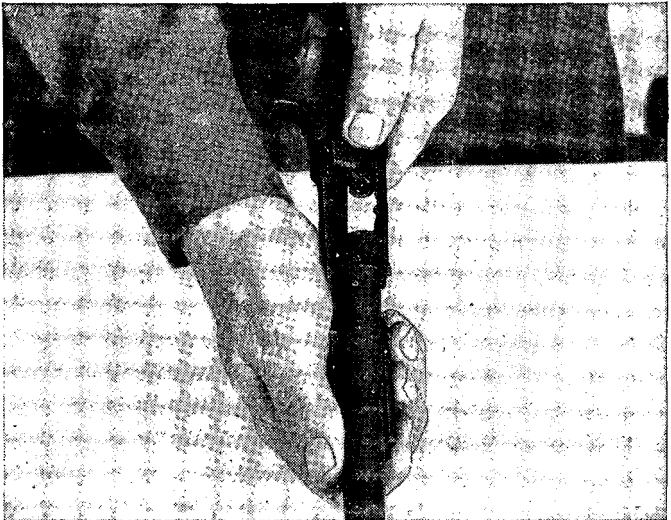

FIGURE 10.—Assembling operating slide to receiver.

### SECTION III

#### CARE AND CLEANING

■ 12. GENERAL.—The attention given to a weapon of this type determines largely whether it will function properly and shoot accurately. The bore and chamber must be kept in good condition for accurate shooting. It is essential that the receiver and moving parts be kept clean, lubricated, and in good condition for reliability in functioning. Magazines must

be kept free from rust, grit, gum, and dents or other damage in order to function properly.

■ 13. IN GARRISON AND CAMP.—*a. General.*—Keep the carbine well cleaned and oiled so as to preserve its condition and appearance during the periods when no firing is being done. Carbines in the hands of troops should be inspected daily to insure proper condition and cleanliness.

*b. Bore.*—The bore of the carbine will always be cleaned with a cleaning rod inserted from the muzzle. The rod used should be of such length as to permit cleaning the bore without damage to the face of the bolt. If a longer rod is used the bolt must be removed or the face of the bolt protected. This can be done in several ways. The simplest way is to cover the face of the bolt with a cloth stuffed into the receiver. To clean the bore, attach a cloth patch to the cleaning rod. Insert the cleaning rod into the bore at the muzzle and move it back and forth several times. Remove the patch. *CAUTION: In cleaning the bore, care must be taken not to foul the gas port with threads from the cleaning patch itself or with other extraneous matter.* Repeat until several successive patches come out absolutely clean. Inspect the bore. If the bore is clean, saturate a patch in light rust-preventive compound and swab the bore thoroughly so that all interior surfaces have a coating of the compound. If the bore still has residue in it swab it with a patch saturated with rifle bore cleaner, until it is clean, then apply the rust preventive.

*c. Chamber.*—The chamber should be cleaned when the bore is cleaned. A roughened or rusty chamber may cause cartridges to stick. To clean the chamber use a chamber cleaning brush and scrub the chamber vigorously. After this scrubbing, the chamber is further cleaned and oiled in the process of cleaning the bore.

*d. Exterior surfaces.*—To clean the screw heads and crevices, use a small cleaning brush or small stick. To clean the metal surfaces, wipe with a dry cloth to remove moisture, perspiration, and dirt; then wipe with a cloth containing a small quantity of light preservative lubricating oil. A light film of this oil should be applied to all moving parts, and this protective film should be maintained at all times. The

stock and hand guard should be wiped with raw linseed oil.

*e. Magazines.*—It is imperative that magazines be given the best of care and kept in perfect condition. They should be disassembled, wiped clean and dry, and thinly coated with oil. Dirt that gets into them must be removed. In handling magazines, care should be taken to avoid denting or bending them, especially the lips of the mouth of the magazine.

*f. After cleaning.*—After cleaning the carbine, place it in the rack without covering and without a plug in the muzzle or chamber. Muzzle covers, carbine covers, rack covers, and plugs must not be used because they collect moisture and promote rust. To protect the carbines from dust, covers may be placed over racks when squad rooms or tents are swept; they must be removed after the rooms have been swept.

■ 14. PREPARATORY TO FIRING.—The following procedure before firing insures efficient functioning of the carbine:

- a.* Dismount main groups.
- b.* Wipe oil or grease from the bore.
- c.* Thoroughly clean and lightly oil all metal parts. Use light preservative lubricating oil.
- d.* Apply a thin, uniform coating of light preservative lubricating oil to the parts listed below:
  - (1) Bolt lugs (locking and operating).
  - (2) Bolt guides.
  - (3) Cocking cam on bolt.
  - (4) Piston.
  - (5) Contact surfaces of barrel and operating slide.
  - (6) Operating slide cam.
  - (7) Operating slide guide groove in receiver and barrel.
  - (8) Operating slide spring.
  - (9) Operating slide spring guide rod.

*CAUTION: Do not apply oil to the under surface of the bolt, as the introduction of oil into the chamber may lead to the generation of excessive pressure.*

*e.* Assemble carbine and rub all outer surfaces with a lightly oiled rag to remove dust.

■ 15. AFTER FIRING.—The bores of all carbines must be thoroughly cleaned by the evening of the day on which they are